

Logamatic EMS RC25 programming unit

For users

Read carefully before
use.

Overview of controls



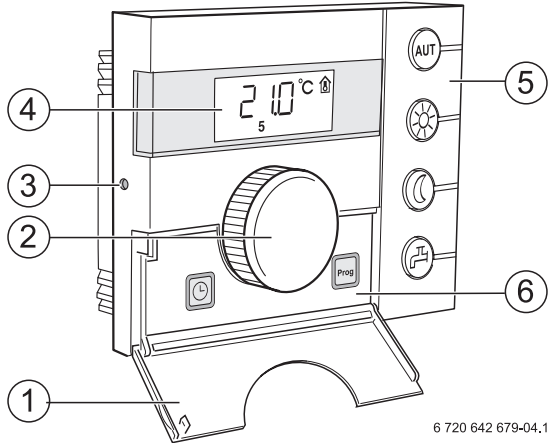

Key to diagram:

- 1 Flap; pull the recessed grip on the left to open
- 2 Rotary selector for changing values and temperatures or for navigating through the menus
- 3 Pin button
- 4 Display



6 720 642 679-04,1RS



5 Keys for basic functions:

-  "AUT" (automatic)
-  "Day mode" (manual)
-  "Night mode" (manual)
-  "DHW"

When the LED lights up,

- the switching program is active (automatic switchover between day and night room temperatures).
- the heating system operates at the set day room temperature. DHW heating is on (factory setting).
- the heating system operates at the set night room temperature. Frost protection is active. DHW heating is off (factory setting).
- the DHW temperature has fallen below its set value. Pushing this key means DHW will be heated up again (the LED flashes during heat-up).

6 Keys for additional functions:

-  "Prog" (program)
-  "Time"

Function:

Selecting a heating program

Set the time

In automatic mode, an additional LED lights up with the "AUT" LED to indicate the current operating status ("day mode" or "night mode"). Exception: in the case of boilers with UBA, only the "AUT" LED illuminates. The "DHW" LED on boilers with UBA will not illuminate.

Contents

1	Symbols and safety precautions	5
1.1	Key to symbols	5
1.2	Safety instructions	6
2	Product information	7
2.1	Product description	7
2.2	Correct use	7
2.3	EU Declaration of Conformity	7
2.4	Cleaning	7
2.5	Disposal	7
3	Getting started	8
4	Principles of operation	11
4.1	Display	11
4.2	Changing the room temperature directly	12
4.3	Notes on range of functions	12
4.4	Selecting a heating circuit	13
4.5	Shutting down/switching off	14
5	Function control	15
5.1	Selecting the operating mode	15
5.2	Setting the room temperature	17
5.2.1	Changing the room temperature temporarily	18
5.2.2	Setting the room temperature for the current operating mode	19
5.2.3	Setting the room temperature for an operating mode which is not the current mode	19
5.3	Setting DHW functions	20
5.3.1	Checking or changing the DHW temperature	20
5.3.2	Heating DHW only once	21
5.4	Setting the time and day	22
5.5	Heating program selection	23
6	Information on setting the programming unit	25
6.1	Types of control	25
6.2	Tips for energy efficiency	26

7	Environment / disposal	27
----------	-------------------------------------	-----------

8	Troubleshooting	28
8.1	Frequently asked questions	28
8.2	Fault and service displays	30
8.3	Clearing faults (reset)	33

	Index	34
--	--------------------	-----------

1 Symbols and safety precautions

1.1 Key to symbols

Warnings

	Warnings in this document are framed and identified by a warning triangle printed against a grey background.
--	--

	If there is a danger due to electricity, the exclamation mark in the warning triangle is replaced by a lightning symbol.
--	--

Keywords at the start of a warning indicate the type and seriousness of the ensuing risk if measures to prevent the risk are not taken.

- **NOTE** indicates that material losses may occur.
- **CAUTION** indicates that minor to medium injury may occur.
- **WARNING** indicates that severe injury may occur.
- **DANGER** indicates a risk to life.

Important information

	Important information where there is no risk to people or property is indicated with the adjacent symbol. It is bordered by lines above and below the text.
--	---

Additional symbols

Symbol	Explanation
▶	Action step
→	Cross-reference to other parts of this document or to other documents
•	List/list entry
–	List/list entry (level 2)

Tab. 1

1.2 Safety instructions

Installation and commissioning

- ▶ Observe these instructions to ensure satisfactory operation.
- ▶ The appliance must only be installed and commissioned by an approved contractor.

Risk to life from electric shock

- ▶ Ensure that electrical connections are only made by authorised electrical contractors.
- ▶ Observe the connection diagram.
- ▶ Before installation, isolate all poles of the power supply. Secure against unintentional reconnection.
- ▶ Never install this appliance in wet rooms.
- ▶ Never connect this appliance to the 230 V mains.

Damage due to operator error

Operator errors can lead to injuries and/or material losses.

- ▶ Ensure that children never operate this appliance unsupervised or play with it.
- ▶ Ensure that only individuals who can operate this appliance correctly have access to it.

Warning: frost

The heating system can freeze up in cold weather if it is not in operation:

- ▶ Leave the heating system permanently switched on.
- ▶ Enable frost protection.
- ▶ In case of faults: remedy any faults immediately.

2 Product information

2.1 Product description

The programming unit makes it easy to operate your Buderus heating system with Energy Management System (EMS). For example, simply pressing one key starts DHW heating at any time; alternatively, using the rotary selector can change the room temperature in the entire home. The thermostatic radiator valves only need to be adjusted if an individual room is too cold or too hot. The automatic control with the adjustable switching program ensure energy efficient operation by reducing the room temperature at certain times or by shutting down the entire heating system (adjustable night setback).

The heating system is controlled in such a way that you benefit from optimum heating comfort and minimum energy consumption.

2.2 Correct use

The programming unit must only be used to operate and control Buderus heating systems in domestic and commercial buildings.

The boiler must be equipped with EMS (energy management system) or UBA (universal burner controller). We recommend always operating the heating system with a programming unit (otherwise the system only operates in emergency mode).

2.3 EU Declaration of Conformity

The design and operation of this product conforms to European Directives and the supplementary national requirements. Its conformity is demonstrated by the CE designation. You can call up the Declaration of Conformity for this product on the internet at www.buderus.de/konfo or request a copy from your local Buderus sales office.

2.4 Cleaning

- ▶ Clean the programming unit only with a damp cloth.







2.5 Disposal

- ▶ Dispose of packaging in an environmentally responsible manner.
- ▶ When replacing components, dispose of the used ones in an environmentally responsible manner.













3 Getting started

Setting room temperatures (→ Chapter 5.2, page 17)

Initial situation: the flap is closed.





What do I do ...	Operation	Input range	Factory setting
<p>if it is temporarily too cold/hot in the entire home on a particular day?</p>	<ul style="list-style-type: none"> ▶ Turn the rotary selector  to set the required room temperature. ▶ Release the rotary selector. The modified room temperature is saved ("temporary set room temperature" ) is saved. The standard display reappears. ▶ Press one of the keys ,  or  to cancel the temporary set room temperature and to enable the selected operating mode. <p>In automatic mode, the modified room temperature remains active until the next changeover between night/day mode.</p>		
<p>if it is permanently too cold/hot in the entire home? → Changing the room temperature in automatic mode</p>	<ul style="list-style-type: none"> ▶ To change the day/night time room temperature in automatic mode: hold down key  and simultaneously turn rotary selector . The value can be changed 	As for day/night	21 °C/ 17 °C

Tab. 2 Getting started - setting temperatures

What do I do ...	Operation	Input range	Factory setting
<p>for one-off heating outside the usual times (outside the switching program)?</p> <p>→ Manual day mode (“continuous heating”); automatic mode is switched off</p>	<p>▶ Activate manual day mode: hold down key  and simultaneously turn rotary selector .</p> <p>The value can now be changed.</p> <p>The LED adjacent to key  illuminates.</p> <p>To end the one-off heating phase:</p> <p>▶ Activate automatic mode again: press .</p> <p>The LED next to key  illuminates.</p>	6 °C – 30 °C	21 °C
<p>to save energy during long absences?</p> <p>→ Manual night mode (“permanently reduced”); automatic mode is switched off</p>	<p>▶ Activate manual night mode: hold down key  and simultaneously turn rotary selector .</p> <p>The value can be changed.</p> <p>The LED next to  lights up.¹⁾</p> <p>When you return:</p> <p>▶ Activate automatic mode again: press .</p> <p>The LED next to key  illuminates.</p>	5 °C – 29 °C	17 °C
<p>if the DHW temperature is too cold/hot?</p>	<p>▶ Hold down  and simultaneously turn rotary selector .</p> <p>The value can be changed.</p>	30 °C – 60(80) °C	60 °C

Tab. 2 Getting started - setting temperatures

Getting started – additional functions

What do I do ...	Operation	Further information
to set the time?	<ul style="list-style-type: none"> ▶ Open flap. ▶ Hold down  and simultaneously turn rotary selector . The time can be set. 	→ page 22
to select the heating program?	<ul style="list-style-type: none"> ▶ Open flap. ▶ Hold down  and simultaneously turn rotary selector . The heating program can be selected. 	→ page 23

Tab. 3 Getting started – additional functions

4 Principles of operation

4.1 Display

The display shows set and actual values and temperatures, e.g. the actual room temperature (factory-set to be the permanent display).

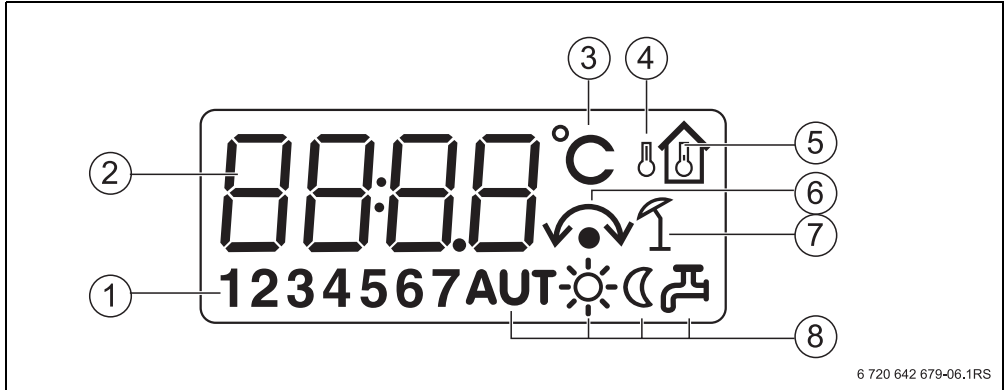

6 720 642 679-06.1RS

Fig. 1 Display elements explained

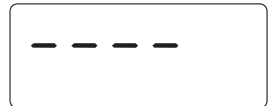

- 1 Day (1 = Mo, 2 = Tu, ...7 = Su)
- 2 Set or actual value/temperature
- 3 "Temperature" display in °C
- 4 "Outside temperature" display
- 5 "Actual room temperature" display
- 6 Display:
 - a) Room temperature can now be adjusted or
 - b) Room temperature has temporarily changed
- 7 "Summer mode" display
- 8 Operating status symbols

The display shows four horizontal bars if you try to change a value which cannot be modified or if an adjustment is not possible.





4.2 Changing the room temperature directly

If your entire home is too cold or too hot, raise or reduce the room temperature using the rotary selector, and leave the thermostatic radiator valves unchanged.

- ▶ Turn the rotary selector  to set the required room temperature.
- ▶ Release the rotary selector.
The modified room temperature is saved ("temporary set room temperature" ) is saved.
The standard display reappears.



The temporary temperature setting is retained until you press one of the keys ,  or  or until the heating system changes its operating mode (for example, into night mode).

For further ways to change the room temperature, see Chapter 5.2, page 17.

4.3 Notes on range of functions

These instructions describe all possible functions of the programming unit. Some of these functions may not be available, depending on which boiler and version of the burner control unit are used. For more information, refer to the relevant chapter. Consult your heating contractor if you have further questions.

4.4 Selecting a heating circuit

What is a heating circuit?

A heating circuit describes the circuit taken by the heating water from the boiler to the radiators and back again. Multiple heating circuits can be connected to one boiler; for example, one heating circuit for radiators and another heating circuit for underfloor heating. The radiators are supplied with a higher flow temperature than the underfloor heating system. The flow temperature is the temperature of the heating water generated by the boiler as it flows into the heating circuit.

The programming unit can be tied into the Energy Management System (EMS) by two different methods:

- As the only programming unit in the system (factory setting): the programming unit is installed in the living space or on the boiler.
Example: detached house with one heating circuit. If DHW is to be controlled, an RC35 programming unit will be needed to comply with part L.
- As a remote control for one heating circuit: ¹⁾
The RC25 programming unit is operated in unison with a higher programming unit (e.g. RC35). The RC35 programming unit is installed either in the living space or on the boiler, and regulates one heating circuit (e.g. for the main apartment). The RC25 programming unit captures the room temperature in a separate living area and regulates this second heating circuit. Basic settings for the heating system are made at the RC35. Consequently, these settings become available for the heating circuit with the RC25 programming unit.
Examples: underfloor heating on one floor, radiators on another; or a flat together with a separate living area or clinic.

1) Not available on boilers with UBA.

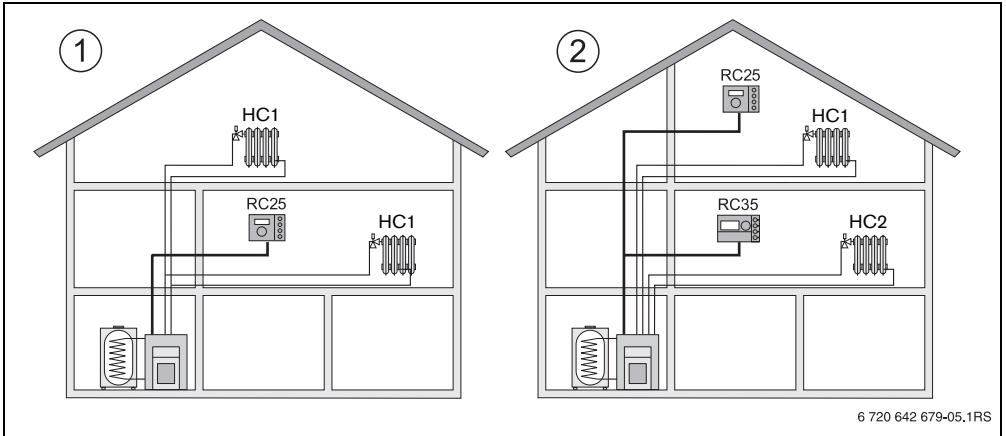

Fig. 2 Options for a heating system with one or two heating circuits

- 1 One programming unit controls one heating circuit. (Must be used in conjunction with RC35 to comply with part L).
- 2 Each heating circuit has its own programming unit / remote control unit.

4.5 Shutting down/switching off

The RC35 programming unit is powered via the heating system and remains permanently on. The heating system is only switched off for maintenance work, for example.

- ▶ To start up and shut down the heating system: set the ON/OFF switch on the boiler programming unit to **1** (ON) or **0** (OFF).

i After shutting down or in the event of a power failure, the time and day are retained for several hours. All other settings are retained permanently.

5 Function control

This chapter describes how you can change the room and DHW temperatures. You control these functions by pressing a key on the r.h. side or behind the programming unit flap, or by turning the rotary selector.

5.1 Selecting the operating mode



You may operate the programming unit in two different ways:

- In automatic mode
- In manual mode

You can activate the operating mode directly by pressing the specified key.

Operating mode	Key	Explanation
Automatic (recommended setting)		<p>The switching program is active. The system will change over automatically between day mode and night mode at the set time (switching point).¹⁾ At night the heating system will operate at a reduced room temperature (factory setting; night shutdown is also possible).</p> <p>DHW heating is on during the day and off at night (factory setting).</p> <p>The LED for the automatic key illuminates, along with the LED for either day or night mode, depending on which is currently active.</p>

Tab. 4 Explanation of the operating modes

Operating mode	Key	Explanation
Manual daytime operation Continuous heating		<p>Factory setting: 21 °C.</p> <p>Manual day mode is useful if you want to heat outside the usual times. Automatic mode is switched off.</p> <p>DHW heating is on (factory setting).</p> <p>Only the day mode LED illuminates.</p>
Manual nighttime operation Permanently reduced		<p>Factory setting: 17 °C.</p> <p>The heating system operates with a reduced room temperature (factory setting). Manual night mode is useful if you are occasionally absent for long periods. Automatic mode is switched off.</p> <p>DHW heating is off (factory setting).</p> <p>Only the night mode LED illuminates.</p>

Tab. 4 Explanation of the operating modes

- 1) The automatic day and night modes correspond to the manual day and night modes. The only difference lies in the automatic changeover.



If the heating system operates under weather-compensated control (→ Chapter 6.1, page 25): during spring and autumn, you may feel that your home is too cold, even though your heating system is in summer mode on account of the outside temperature (only DHW heating). In that case, select manual mode to heat on an hourly basis.

5.2 Setting the room temperature



NOTICE: System damage due to frost!

If room temperatures are set below 10 °C, rooms may cool down so much that pipes in external walls (for example) may freeze in cold weather.

- ▶ Set room temperatures higher than 10 °C.

Generally, you can adjust the room temperature using the rotary selector. This can be done in three different ways:

- Changing the room temperature temporarily. The modified settings are retained until the heating system changes into a different operating mode (e.g. night mode).
- Changing the room temperature for the current operating mode (e.g. automatic day mode). The modified setting applies to automatic day mode from then onwards.
- Changing the room temperature for an operating mode that is not currently selected (e.g. changing the night room temperature during the day). The modified setting applies to this operating mode from then onwards.











The actual room temperature is shown as the permanent display. Your heating contractor can also set a different permanent display.

5.2.1 Changing the room temperature temporarily



You are currently in automatic mode or in manual mode and would like to change the room temperature ("temporary set room temperature") temporarily. A temporary set room temperature is indicated by symbol .

This function is not supported in conjunction with the RC30 programming unit. Instead, use manual mode (→ Chapter 5.1, page 15).

Initial situation: the flap is closed.

	Operation	Result
1.	Turn rotary selector  The current set room temperature is displayed. Turn rotary selector  further. Turn the rotary selector clockwise to increase the room temperature and anti-clockwise to lower it.	
2.	When you have reached the required room temperature, release the rotary selector. The modified room temperature ("temporary set room temperature" ) is saved (no longer flashes). The permanent display appears again.	
In manual mode, the LED next to  is not lit up. In this case, the modified room temperature applies until you press  ,  or  .		

Ending a temporary change in room temperature





- ▶ To return to automatic mode, press .
The automatic program uses the temperatures normally set for day and night mode.
- ▶ To return to manual mode, press  or .
The temperatures normally set for day or night mode will be used.



If holiday mode is active for the relevant heating circuit in conjunction with the RC35 programming unit (RC25 programming unit as remote control), then the set holiday temperature rather than the temporary set room temperature can be changed at the RC25 programming unit.





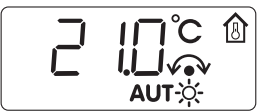

5.2.2 Setting the room temperature for the current operating mode

The set room temperature applies to the currently enabled heating mode, i.e. day or night mode. You can recognise the currently enabled heating mode because the LED of the respective symbol illuminates. You are currently in automatic mode and would like to change the room temperature.

	Operation	Result
1.	Hold down  and simultaneously turn rotary selector  Turn rotary selector  further. Turn the rotary selector clockwise to increase the room temperature and anti-clockwise to lower it.	
2.	When you have reached the required room temperature, release the rotary selector. Automatic mode is now active with the modified room temperatures. The LED next to key  illuminates. The permanent display will then appear again.	

5.2.3 Setting the room temperature for an operating mode which is not the current mode

You may also adjust the room temperature for an operating mode that is not currently enabled. For example, you are currently in automatic "Day" mode and would like to alter the set night temperature.

	Operation	Result
1.	Hold down  and simultaneously turn rotary selector  Turn rotary selector  further. Turn the rotary selector clockwise to increase the room temperature and anti-clockwise to lower it.	
2.	When you have reached the required room temperature, release the rotary selector. Automatic mode is now active with the modified room temperatures. The LED next to key  illuminates. The permanent display will then appear again.	

5.3 Setting DHW functions

Risk of scalding from DHW temperatures over 60 °C!



WARNING: Risk of scalding!

The factory setting for the DHW temperature is 60 °C. There is a risk of scalding at the hot water draw-off points if the temperature is set higher than this and also following thermal disinfection.



- ▶ If the temperature set is higher than 60 °C or following thermal disinfection, never open any hot water tap without mixing in cold water as well.

The programming unit also offers you the option of heating DHW in an energy-conscious manner. The setting is subject to how the programming unit was installed (→ Chapter 6.1, page 25):

- If the RC25 programming unit operates as the only programming unit in the system, DHW heating commences automatically 30 minutes prior to the start of day mode of the heating program. DHW is not produced during night mode. In day mode, the DHW circulation pump is started twice per hour for three minutes to safeguard the constant supply of taps with hot water.¹⁾ The DHW temperature can be set to a maximum of 60 °C (= factory setting). For UK an RC35 must be used for DHW control to comply with part L.
- If the RC25 programming unit is installed as a remote control for one heating circuit,²⁾ then DHW heating and the operation of the DHW circulation pump will be set for the entire heating system with the higher programming unit (e.g. RC30/RC35). The set DHW temperature can be changed with the RC30/RC35 or the RC25 programming units; however, the setting range of the RC30/RC35 programming units applies (maximum 80 °C).

5.3.1 Checking or changing the DHW temperature

Initial situation: the flap is closed.

	Operation	Result
1.	Hold down  and simultaneously turn rotary selector  . The value can be changed.	
2.	When you have reached the required DHW temperature, release the rotary selector. The modified temperature is saved. The standard display appears again.	

1) Function dependent on the boiler used.





2) Function not available on boilers with UBA.

5.3.2 Heating DHW only once¹⁾

To save energy, during day mode DHW is only reheated automatically when its temperature falls 5 °C below the set DHW temperature.

If you need large amounts of hot water one evening or outside the set times for day mode, you can heat up the DHW.

Initial situation: the flap is closed.

Operation	
1.	The LED of key  illuminates if the DHW temperature falls below the set value. To heat up the DHW manually: press  . The LED at key  flashes. Heat-up starts, and is later terminated automatically.
2.	If you want to stop the heating process, press  again.











Subject to the size of the DHW cylinder and the boiler output, DHW will be available after approx. 10 – 30 minutes. With instantaneous water heaters or combi boilers, DHW is available almost immediately.

1) Function not available on boilers with UBA.

5.4 Setting the time and day

Your heating system requires the time and day to operate correctly. You can set both at the programming unit, e.g. following a prolonged power failure (the clock continues to operate even after a power failure lasting a few hours).

If the RC25 programming unit has been assigned to an RC30/RC35 programming unit as a remote control, the time and day can only be set at the RC30/RC35 programming unit. The RC25 programming unit adopts the settings of the RC30/RC35 programming unit.

	Operation	Result
1.	Open flap.	
2.	Hold down  and simultaneously turn rotary selector  . The current time can be set.	
3.	Release  . The time is saved.	
4.	Hold down  and simultaneously turn rotary selector  . The current day (1 = Mo, 2 = Tu, ... 7 = Su) can be selected.	
5.	Release  . The day is saved.	

5.5 Heating program selection

Automatic mode ensures automatic changeover between day and night mode at defined times. The factory settings means 21 °C or 17 °C are set for day or night mode.





Before you select a heating program, consider the following:

- At what time in the morning should your home be warm? Is this time also subject to the day of the week?
- Are there days when you don't want to heat during the day?
- From what time in the evening do you no longer need to heat? This may also depend on the day of the week.

If the RC25 programming unit is installed as a remote control unit in conjunction with an RC30/RC35 programming unit, heating programs from the RC30/RC35 can be used by the RC25 programming unit (so-called "Own programs", → Tab. 5, page 24).

The programming unit has eight different, preset heating programs. See the following Tab. 5, page 24 for a summary of the times of these preset heating programs.

Please check which heating program best meets your requirements to optimise heating comfort and energy efficiency. Primarily check the number and times of the switching points for day and night mode. Program **Pr1** ("family" program) is preset at the factory.

	Operation	Result
1.	Open flap.	
2.	Hold down  . The currently selected heating program is displayed.	
3.	Select the required heating program using rotary selector  (→ Tab. 5, page 24).	
4.	Release  . The selected program is saved. The permanent display will then appear again.	



The selected heating program will only be effective if automatic mode has been selected (→ Chapter 5.1, page 15).

Start and stop points in the heating programs

No.	Program	Day	ON	OFF	ON	OFF	ON	OFF
Pr1	Family (factory setting)	Mo-Th	5:30	22:00				
		Fr	5:30	23:00				
		Sa	6:30	23:30				
		Su	7:00	22:00				
Pr2	Early morning (early shift work)	Mo-Th	4:30	22:00				
		Fr	4:30	23:00				
		Sa	6:30	23:30				
		Su	7:00	22:00				
Pr3	Evening (late shift work)	Mo-Fr	6:30	23:00				
		Sa	6:30	23:30				
		Su	7:00	23:00				
Pr4	Morning (part-time work in the morning)	Mo-Th	5:30	8:30	12:00	22:00		
		Fr	5:30	8:30	12:00	23:00		
		Sa	6:30	23:30				
		Su	7:00	22:00				
Pr5	Afternoon (part-time work in the afternoon)	Mo-Th	6:00	11:30	16:00	22:00		
		Fr	6:00	11:30	15:00	23:00		
		Sa	6:30	23:30				
		Su	7:00	22:00				
Pr6	Midday (at home at midday)	Mo-Th	6:00	8:00	11:30	13:00	17:00	22:00
		Fr	6:00	8:00	11:30	23:00		
		Sa	6:00	23:00				
		Su	7:00	22:00				
Pr7	Single	Mo-Th	6:00	8:00	16:00	22:00		
		Fr	6:00	8:00	15:00	23:00		
		Sa	7:00	23:30				
		Su	8:00	22:00				
Pr8	Elderly	Mo-Su	5:30	22:00				
Pr9	New program	Constant heating mode (24 h). This is displayed on the RC25 programming unit whilst a new heating program is entered in the RC30/RC35 programming unit (only if the RC25 is used as a remote control). ¹⁾						
Pr0	Own program (from RC30/RC35)	Only if the RC25 programming unit is set up as a remote control: Enables "Own program 1" set up in the RC30/RC35 programming unit for the heating circuit of the RC25 programming unit. ¹⁾						
Pr10	Own program (from RC35)	Only if the RC25 programming unit is set up as a remote control in conjunction with the RC35: Enables "Own program 2" set up in the RC35 programming unit for the heating circuit of the RC25 programming unit. ¹⁾						

Tab. 5 Heating programs (ON = day mode, OFF = night mode)

1) Function not available on boilers with UBA.

6 Information on setting the programming unit

6.1 Types of control

The heating system can be operated in three control modes. Depending on your requirements, your heating contractor will select and set up one of these options:

Room temperature control

With this control mode, the programming unit must be fitted in a room that is fairly typical for the home. The programming unit records the room temperature in this “reference room”. Control of the flow temperature is determined by the set room temperature and the actual room temperature. Consequently external temperature influences in the reference room (e.g. open windows, sunlight or heat from a fireplace) will affect your entire home.

Set the room temperature of your home or reference room at the programming unit. You can produce higher or lower temperatures in the other rooms by adjusting the thermostatic radiator valves.

Weather-compensated control

The temperature of the heating water in the boiler is defined by the heating curve. You can select whether this heating curve will be influenced solely by the outside temperature, or whether the temperature in the reference room should also have an influence.

- **Purely weather-compensated control:**

The outside temperature is captured by a temperature sensor. The flow temperature is calculated solely on the basis of the outside temperature in accordance with the set heating curve.

You can set the room temperature for the entire home at the programming unit (which will shift the heating curve up or down). You must adjust the thermostatic radiator valves in every room in order to achieve the required room temperature.

- **Weather-compensated control with room temperature hook-up:**

With this control mode the flow temperature is primarily determined by the outside temperature, but is also influenced by the room temperature to the extent selected by your heating contractor.



The following applies to **room temperature control** and for weather-compensated control **with room temperature hook-up:**

The thermostatic radiator valves in the “Reference room” (the room where the programming unit is installed) **must be fully open!** Control of the flow temperature is determined by the room temperature recorded there. It must not be limited by closed thermostatic valves.

6.2 Tips for energy efficiency

- You can save around 6 % on your heating costs by reducing the daytime room temperature by 1 °C.
- Only heat if you need warmth. Use the switching programs for automatic night setback.
- Air your home wisely: leave the windows wide open for a few minutes rather than leaving them slightly open all the time.
- Close the thermostatic radiator valves while airing rooms.
- Make sure that your windows and doors form a proper seal.
- Never position large objects such as a sofa immediately in front of radiators (maintain a clearance of at least 50 cm). Otherwise, the heated air cannot circulate and heat the room adequately.
- You can also increase the energy efficiency of your DHW heating: compare the times when you want your rooms to be warm with the times when you need hot water. It may be practical to use a separate switching program for DHW heating.
- Arrange for your heating contractor to service your heating system annually.



7 Environment / disposal

Environmental protection is a fundamental corporate strategy of the Bosch Group. The quality of our products, their economy and environmental safety are all of equal importance to us and all environmental protection legislation and regulations are strictly observed. We use the best possible technology and materials for protecting the environment taking account of economic considerations.

Packaging

Where packaging is concerned, we participate in country-specific recycling processes that ensure optimum recycling.

All packaging materials are environmentally compatible and can be recycled.

Used appliances

Used appliances contain materials that should be recycled.

The components are easy to separate and the plastics carry identification markings. This allows the various assemblies to be appropriately sorted for recycling or disposal.

8 Troubleshooting

This chapter deals with frequently asked questions about your heating system. This will in many cases enable you to eliminate suspected faults. At the end of the chapter you will find a table listing faults and corresponding remedies.

8.1 Frequently asked questions

Why do I set a room temperature, even though it is not recorded?

When you set the room temperature – even if it is not recorded, as with weather-compensated control – you are changing the heating curve. This changes the room temperature, because the temperature of the heating water changes and with it the temperature of the radiators.

Why does the room temperature measured with a separate thermometer not correlate with the set room temperature?

The room temperature is influenced by a number of different variables. If the RC25 programming unit is installed on a cold wall, it will be influenced by the cold temperature of the wall. It will be influenced by the heat from a fireplace or chimney, for example, if it is installed in a warm part of the room. Therefore, a separate thermometer can indicate a different room temperature than that set at the RC25 programming unit. To compare the actual room temperature with the values measured by another thermometer, the following is important:

- The separate thermometer and the room controller must be physically close to each other.
- The separate thermometer must be accurate.
- When comparing, do not measure the room temperature when the heating system is heating up, as the two devices may react at different speeds to the change in temperature.

If you have followed these instructions and you can still detect a discrepancy, you can calibrate the room temperature display (→ page 17).

Why do the radiators get too hot when the outside temperature is relatively high?

If you have a heating system with one heating circuit and no mixing valve (heating circuit 1), this is normal. The pump only starts up when the boiler reaches a predefined flow temperature. If the flow temperature is higher than required based on the outside temperature, the radiators may get hotter for a short time. The heating control unit detects this and responds accordingly after a short time. Do not adjust the thermostatic valves on the radiators and wait until the set room temperature is reached. Even in summer mode, radiators may be heated briefly under specific circumstances: namely when the pump is started up automatically at a predefined interval to prevent it from “seizing up” (jamming). If the pump happens to start immediately after DHW heating, the unusable residual heat is dissipated via the heating circuit and the radiators.

Why does the pump run at night, even though the home is not being heated at all or only very little?

This depends on the setting chosen by your heating contractor for night setback.

- **Reduced operation:** The pump still runs even if the home is only being heated a little to achieve a low room temperature.
- **Shutdown mode:** The heating system (and therefore also the pump) is automatically shut down in night mode. If the outside temperature falls below the frost protection temperature, the pump is automatically switched on by the "Frost protection" function.
- **Shutdown mode and Room setback mode:** The heating system is switched on automatically when the captured temperature falls below the set value. The pump will then also start.

The actual room temperature is higher than the set room temperature. Why is the boiler still running?

The boiler may be running to heat up DHW. Your heating system can be set to three possible control modes (→ page 25):

- Room temperature control: The boiler shuts down when the set room temperature has been reached.
- Weather-compensated control: The heating system runs on the basis of the outside temperature.
- Weather-compensated control with room temperature hook-up: The heating system takes advantage of both the above control modes.

The boiler can still operate in the latter two cases, even if the captured room temperature is higher than the set room temperature.

8.2 Fault and service displays

The programming unit makes a distinction between three types of messages:

- Service message
- Fault message (= system fault; incorrect settings on the programming unit, or component faulty)
- Service messages (indicating that some maintenance work is required)



NOTICE: System damage due to frost!

The heating system can freeze up if it has been switched off through a fault shutdown.

- ▶ Try and clear the fault.
- ▶ If that is not possible, notify your heating contractor immediately.



The faults depend on the boiler used. Information about the faults can be found in the boiler documentation.

“Code” column in Tab. 6



The messages are identified by codes. These inform your heating contractor about the possible cause.

The codes are issued in two parts. The first indicates the service code (display code) (e.g. **A01**). Turning the rotary selector clockwise displays the fault code (e.g. **816**).





By means of the service code, the display indicates, whether a **Fault Condition** (= system fault) or **service message** is currently active.

1. In case of a fault message, turn rotary selector  clockwise.
The fault code will be displayed.
2. Check whether you can eliminate the fault yourself with a reset (→ Chapter 8.3) or by means of the explanations in Tab. 6.
3. Otherwise notify your heating contractor immediately (stating the code).
4. In case of a service message, check whether the message can be cleared with the aid of the explanations in Tab. 6.
5. Otherwise notify your heating contractor immediately (stating the code).

The following table explains the possible fault and service displays:

Code	Display	Cause	Remedy
	Nothing appears on the display	Heating system has been switched off. The power supply to the heating system has been interrupted.	<ul style="list-style-type: none"> ▶ Switch on the heating system. ▶ Check that the programming unit is correctly seated in its wall mounting base. ▶ Check that the cables on the programming unit wall mounting base are connected.
	After start-up:  In addition, the LEDs flash alternately.	After start-up, data is transferred between EMS/UBA and the RC35 (no fault).	▶ Wait a few seconds.
	When changing a setting: 	This parameter cannot be modified or this setting is not permissible.	

Tab. 6 Fault and service displays

Code		Display	Cause	Remedy
xxx	xxx	Example: 	The heating system or the programming unit has developed a fault. The cause of the fault may be temporary. The heating system automatically returns to standard mode.	If the permanent display does not automatically return: ► Notify your heating contractor.
		The LEDs flash alternately. The display does not flash.		
		In addition the display flashes.	The heating system or the programming unit has developed a fault. If a fault is shown as a flashing code, clear it with a reset.	► Clear the fault (→ Chapter 8.3).
A01	816		Communication to EMS is faulty, possibly due to a loose contact or electromagnetic interference, for example.	► Check that the programming unit is correctly seated in its wall mounting base. ► Check that the cables on the programming unit wall mounting base are connected.
A11	802		Time or date settings are missing. This may have been caused by a lengthy power failure, for example.	► Enter the time or date so that the switching program and other functions can work correctly.
A11	803			
A18	802		Time or date settings are missing. This may have been caused by a lengthy power failure, for example.	► Enter the time or date so that the switching program and other functions can work correctly.

Tab. 6 Fault and service displays

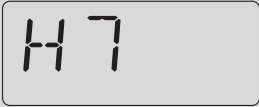
Code	Display	Cause	Remedy
Hxx ¹⁾	Example: 	A service is required. The heating system keeps operating as far as possible.	► Make arrangements to have the system serviced by your heating contractor.
H7 ¹⁾		The water pressure in the heating system has dropped to a low level. This value is only displayed if your heating system is equipped with a digital pressure sensor. Otherwise check the operating pressure from time to time at the pressure gauge.	This is the only service message (H 7) that you can deal with yourself. ► Top up the heating water (→ boiler operating instructions).

Tab. 6 Fault and service displays

1) Function not possible on boilers with UBA.

8.3 Clearing faults (reset)

Some faults can be rectified by resetting the system. This applies to locking faults, for example. Locking faults are those which cause the display on the boiler programming unit to flash.

- Press reset on the boiler programming unit to clear the fault.
 For instructions regarding the reset function on the boiler programming unit, see the technical documentation for the boiler and/or boiler programming unit.
- If the fault cannot be cleared (display continues to flash), notify your heating contractor.

Index

- A**
Automatic mode 15
- C**
Cleaning 7
Continuous heating (manual day) 15
- D**
Day mode 15
DHW temperature, setting 20
DHW, heating up once 20
Disposal 7
- E**
Energy 7
- tips for energy efficiency 26
Environment / disposal 27
- F**
Faults 30
Faults, clearing 33
Flow temperature 13
Frost 6, 33
- faults when there is a risk of frost 30
Frost protection 29
- G**
Getting started 8
- H**
Heating circuit
- Explanation 13
Heating circuit, selecting 13
- M**
Manual day/night mode 15
- N**
Night mode 15
Night setback 29
- O**
Operation modes 15
Outside setback mode 29
Outside temperature, higher 28
- P**
Packaging 27
Permanently reduced (manual night) 15
Power failure 14
Pump 29
- R**
RC25 heating circuits 13
Recycling 27
Reduced mode 29
Reference room 25
Remote control 13
Reset 33
Room setback mode 29
Room temperature
- changing temporarily 18
- discrepancy in displayed temperature ... 28
- too cold/too hot 8
Room temperature control 25, 29
- S**
Safety instructions 6
Shutdown mode 29
Shutting down 14
Start point 24
Stop point 24
Switching off 14
- T**
Temperature, see Room temperature
Thermostatic valves 7, 25
Types of control 25
- U**
Used appliances 27
- W**
Weather-compensated control 25, 29



Notes

Buderus

Cotswold Way, Warndon, Worcester WR4 9SW
Customer service: 0844 892 3004
Technical support: 0844 892 4224

www.buderus-commercial.co.uk

In the UK and IE, Buderus is a brand name
of Bosch Thermotechnology Ltd.

Buderus