

PSW 500, 750, 1000-6 | PSW 750-6 PN6

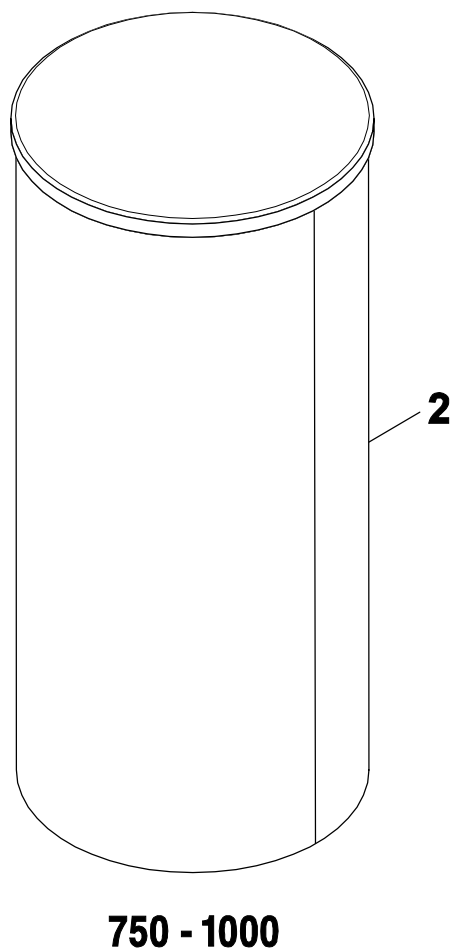

8738893769.aa.R

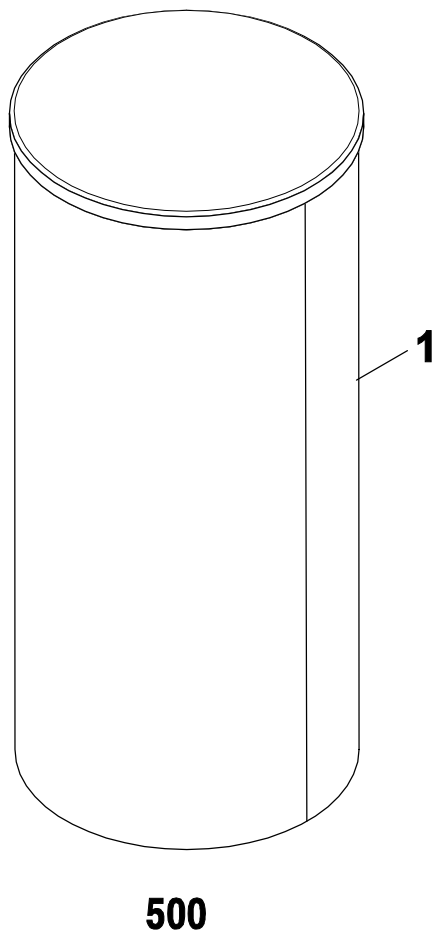

[de] Wichtige Hinweise zur Installation/Montage

Die Installation/Montage muss durch eine für die Arbeiten zugelassene Fachkraft unter Beachtung der geltenden Vorschriften erfolgen.

[en] Important notes on installation/assembly

The installation/assembly must be carried out by a professional who is authorised to do the work, and with due regard to the relevant regulations.

[fr] Instructions importantes pour l'installation/le montage

L'installation/le montage doit être effectué(e) par un spécialiste qualifié pour les opérations concernées et dans le respect des prescriptions applicables.

[bg] Важни указания във връзка с инсталацията/монтажа

Инсталацията/монтажът трябва да се извършва от лицензиран за работите специалист в съответствие с приложимите разпоредби.

[cs] Důležité pokyny k instalaci/montáži

Instalaci/montáž musí při dodržení platných předpisů provést odborný pracovník s příslušným oprávněním pro tyto práce.

[da] Vigtige anvisninger til installationen/monteringen

Installationen/monteringen skal foretages af en godkendt installatør under overholdelse af de gældende forskrifter.

[el] Σημαντικές υποδείξεις για την εγκατάσταση/συναρμολόγηση

Η εγκατάσταση/συναρμολόγηση πρέπει να πραγματοποιείται από εξουσιοδοτημένο για τις εργασίες αυτές τεχνικό προσωπικό, το οποίο θα πρέπει να φροντίζει ώστε να τηρούνται οι ισχύουσες διατάξεις.

[es] Indicaciones importantes para instalación/montaje

La instalación/el montaje lo debe realizar personal especializado autorizado para los trabajos, respetando las prescripciones vigentes.

[et] Olulised juhised paigaldamiseks/montaažiks

Paigaldamist/montaaži tohib läbi viia selleks volitusi omav spetsialist, arvestades kehtivaid nõudeid.

[fi] Belangrijke aanwijzingen betreffende de installatie/montage

De installatie/montage moet worden uitgevoerd door een voor de werkzaamheden geautoriseerde installateur. Hij moet rekening houden met de geldende voorschriften.

[fr] Tärkeitä asennus- ja kokoonpano-ohjeita

Näihin töihin hyväksytyin ammattiasentajan pitää suorittaa asennus- ja kokoonpanotyöt voimassa olevien määräysten mukaisesti.

[hu] Fontos tudnivalók az installáláshoz/szereléshez

Az installálást/szerelést egy, a munkákra felhatalmazott szakembernek kell végeznie, az érvényes előírások figyelembevételével.

[it] Avvertenze importanti per l'installazione/il montaggio

L'installazione/il montaggio deve aver luogo ad opera di una ditta specializzata ed autorizzata in osservanza delle disposizioni vigenti.

[he] מְחַבְרָה לְחֻקֵּי בְּטָחוֹן וְחֻקֵּי מְסֻלָּת

התקנת/הרכבת חייבת להיעשה על ידי מומחה אוטוריזציה בהתאמה עם הנחיות הבטיחות והנחיות המסלוליות.

[lt] Svarbios instaliavimo ir (arba) montavimo nuorodos

Instaliuoti ir montuoti, laikantis galiojančių taisyklių, leidžiama kvalifikuotiems specialistams, kurie buvo įgalioti šiems darbams atlikti.

[lv] Svarīgi norādījumi par iekārtas uzstādīšanu / montāžu

Iekārtas uzstādīšanu/montāžu ir jāveic specializētām sertificētām speciālistam, ievērojot spēkā esošos noteikumus.

[nl] Belangrijke aanwijzingen betreffende de installatie/montage

De installatie/montage moet worden uitgevoerd door een voor de werkzaamheden geautoriseerde installateur rekening houdend met de geldende voorschriften.

[no] Viktig informasjon om installasjon/montering

Installasjonen/monteringen skal gjennomføres av autoriserte installatører, og gjeldende forskrifter skal følges.

[pl] Ważne wskazówki dotyczące instalacji/montażu

Instalacja/montaż muszą być wykonane przez uprawnionego do tego rodzaju prac specjalistę przy zachowaniu obowiązujących przepisów.

[pt] Indicações importantes relativas à instalação/montagem

A instalação/montagem deve ser efetuada por um técnico especializado com qualificações para estes trabalhos, tendo em atenção os regulamentos em vigor.

[ro] Indicații importante privind instalarea/montajul

Instalarea/montajul trebuie realizate de către un specialist autorizat pentru lucrările respective, respectându-se prescripțiile valabile.

[ru] Важные указания по подключению/монтажу

Подключение/монтаж должны выполнять специалисты, имеющие допуск к выполнению таких работ, при соблюдении действующих норм и правил.

[sk] Dôležité pokyny týkajúce sa inštalácie/montáže

Inštaláciu/montáž musí realizovať odborník s oprávnením na výkon týchto prác, pričom musí dodržiavať platné predpisy.

[sl] Pomembni napotki za namestitvev/montažo

Namestitvev/montažo mora izvesti strokovnjak, pristojen za tovrstna dela, ob upošte vanju veljavnih predpisov.

[sr] Važna uputstva za ugradnju i montažu

Ugradnju i montažu moraju da obave samo stručna lica ovlašćena za izvođenje takvih radova koja će poštovati važeće propise.

[sv] Viktiga anvisningar för installation/montering

Installationen/monteringen måste utföras av en behörig och fackkunnig person enligt gällande föreskrifter.

[tr] Kurulum/Montaj ile ilgili önemli uyarılar

Kurulum/Montaj çalışmaları sadece yetkili bayiler tarafından aşağıda belirtilen talimatlar dikkate alınarak yapılmalıdır.

[uk] Важливі вказівки щодо установки/монтажу

Установку/монтаж мають здійснювати фахівці, що мають дозвіл на проведення цих робіт, із дотримання чинних приписів.

[zh] 安装方面的重要提示

必须由受许可承担该项工作的专业人员遵照相关法规进行安装。

[ar] ملاحظات هامة للتركيب/التجميع

يجب أن يتم التركيب/التجميع من قبل متخصص مصرح له بالعمل، مع مراعاة اللوائح السارية.





[fa] تذکرات مهم درباره نصب/مونتاژ

نصب/مونتاژ باید توسط فردی حرفه ای که مجاز به انجام این کار است، و همچنین با توجه کامل به مقررات مربوطه انجام شود.

Ersatzteilliste
Spare parts list

Liste des pièces de rechange
Lista parti di ricambio

Onderdelenlijst
Lista de repuestos

- 4x  80x30x2
- 4x  80x34x2
- 8 — 2x  90x43x2
- 2x  100x48x2
- 6x  110x55x2

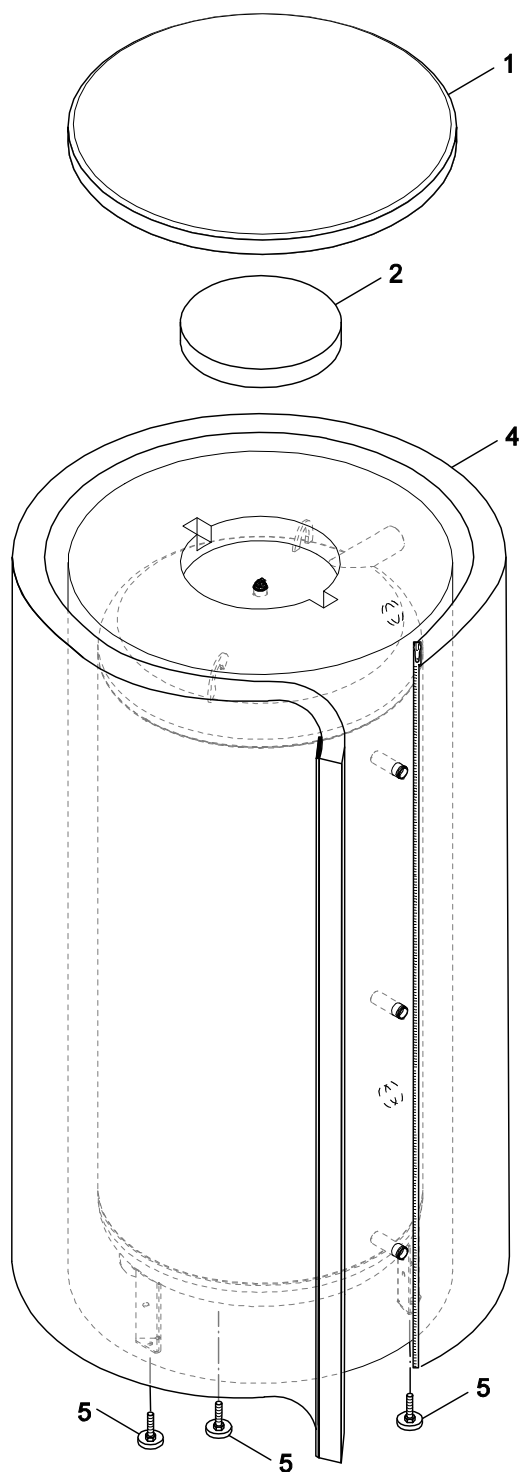
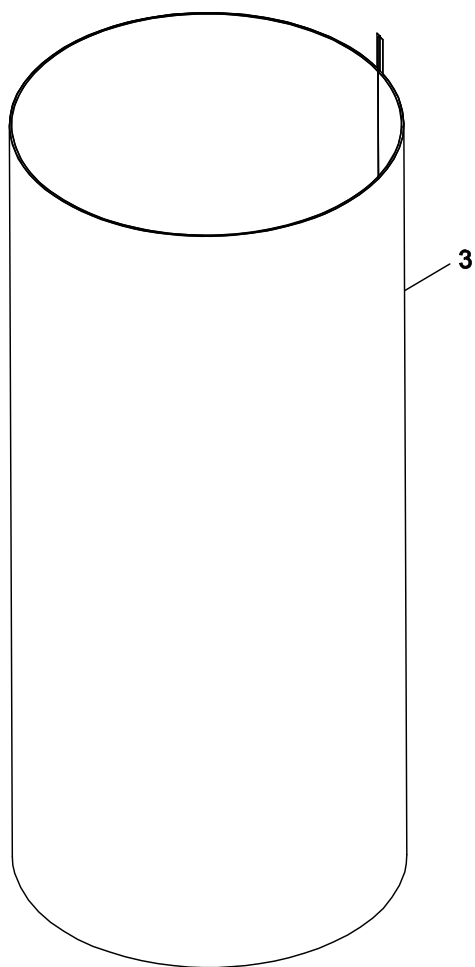

8738893770.aa.R

PSW 500, 750, 1000-6 | PSW 750-6 PN6

1



- Pufferspeicher PSW 500-6
- Buffer cylinder PSW 500-6
- Ballon tampon PSW 500-6
- Accumulatore puffer PSW 500-6
- Bufferboiler PSW 500-6
- Acumulador auxiliar PSW 500-6





Pos	Bezeichnung Description Dénomination Descrizioni Benaming Descripción	Bestell-Nr. Ordering no. Numéro de commande N° d'ordine Bestelnummer Número el ordenar	PG																	Bemerkungen Remarks Remarques Osservazioni Opmerkingen Observaciones			
				PSW 500-6 B	PSW 500-6 C																		
1	Abdeckung D850 Deckel weiss	8 735 100 270	35	■																			
1	Abdeckung D783 Deckel weiss	8 735 100 271	43		■																		
2	Weichschaum Rosette D320x0x50	8 735 100 272	34	■	■																		
3	Folienmantel P500 weiß	8 735 100 578			■																		
4	Isolation P500 ErP B weiss/weiss	8 735 100 582			■																		
5	Zubehör Stellfuß Speicher 500-1000L 3 ST	8 718 590 658			■	■																	
8	Set Rosetten selbstklebend S	8 735 100 321	27	■	■																		
	Logo Junkers	8 711 145 928 0	16	■	■																		
PSW 500, 750, 1000-6 PSW 750-6 PN6				Pufferspeicher PSW 500-6 Buffer cylinder PSW 500-6 Ballon tampon PSW 500-6 Accumulatore puffer PSW 500-6 Bufferboiler PSW 500-6 Acumulador auxiliar PSW 500-6																1			

Ersatzteilliste
Spare parts list

Liste des pièces de rechange
Lista parti di ricambio

Onderdelenlijst
Lista de repuestos

- 6x  D90x38x20
- 12x  D90x25x20
- 1x  D140x58x20

- 4x  80x30x2
- 4x  80x34x2
- 15x  90x43x2
- 2x  100x48x2
- 6x  110x55x2

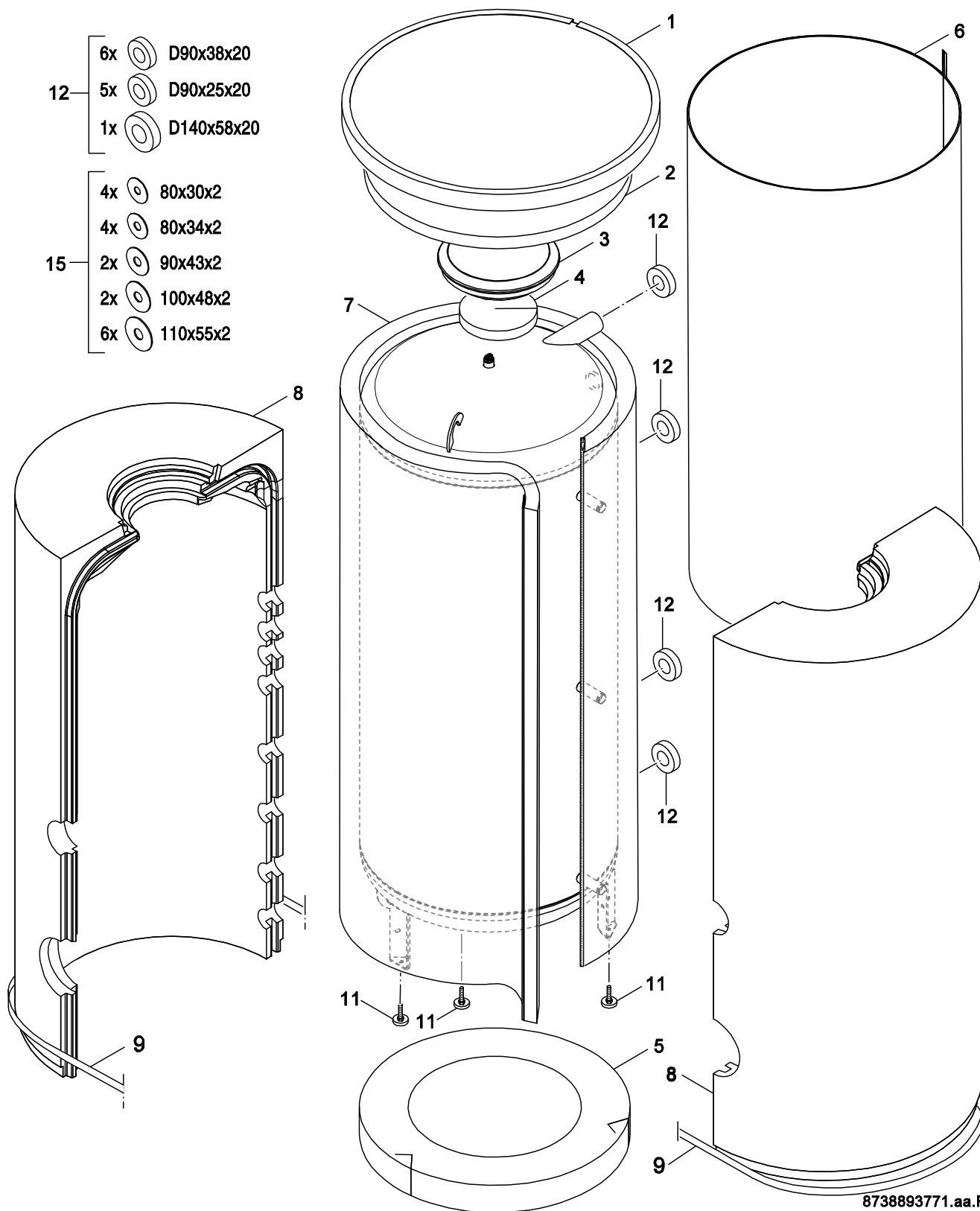

8738893771.aa.R

Pufferspeicher PSW 750-6 - 1000-6
Buffer cylinder PSW 750-6 - 1000-6
Ballon tampon PSW 750-6 - 1000-6
Accumulatore puffer PSW 750-6 - 1000-6
Bufferboiler PSW 750-6 - 1000-6
Acumulador auxiliar PSW 750-6 - 1000-6

PSW 500, 750, 1000-6 | PSW 750-6 PN6

2

Pos	Bezeichnung Description Dénomination Descrizioni Benaming Descripción	Bestell-Nr. Ordering no. Numéro de commande N° d'ordine Bestelnummer Número el ordenar	PG	PSW 750-6 C												Bemerkungen Remarks Remarques Osservazioni Opmerkingen Observaciones
				PSW 750-6 C	PSW 750-6 E	PSW 750-6 PN6 C	PSW 750-6 PN6 E	PSW 1000-6 C	PSW 1000-6 E							
1	Abdeckung Deckel D960 weiss	8 735 100 307	44	■		■		■								
1	Verkleidungsdeckel D950x50 weiß	8 735 100 340	40		■		■		■							
2	Isolierung Deckel 750/1000-80V	8 735 100 079	36		■		■		■							
3	Stopfen EPS Oberteil D370	8 718 541 763 0	35	■		■		■								
4	Weichschaum Rosette D280x0x50	8 735 100 318	32	■		■		■								
5	Isolierung Boden D790x80V	8 735 100 077	34		■		■		■							
5	Isolierung Boden D820x100	8 735 100 305	30	■		■		■								
6	Folienmantel P750 weiss	8 735 100 595		■		■										
6	Folienmantel P1000 weiss	8 735 100 597							■							
7	Isolation Puffer 1000.5V E Bo/Ju	8 735 100 574								■						
7	Isolation Puffer 750.5V E Bo/Ju	8 735 100 577			■		■									
8	Wärmeschutz Speicher P750-C	8 735 100 589	54	■		■										
8	Wärmeschutz Speicher P1000-C	8 735 100 591	54							■						
9	Spannband	8 735 100 317	29	■		■		■								
11	Zubehör Stellfuß Speicher 500-1000L 3 ST	8 718 590 658		■	■	■	■	■	■	■						
12	Set Weichschaum Rosetten P	8 735 100 598	28	■		■		■								
15	Set Rosetten selbstklebend S	8 735 100 321	27	■	■	■	■	■	■	■						
	Thermometer kpl 30-80 C	5236200		■	■	■	■	■	■	■						
	EPP-Abdeckung für Fühlerhülse verp	7 735 501 429		■	■	■	■	■	■	■						
	Digital-Thermometer DTA	7 747 201 004		■	■	■	■	■	■	■						
	Logo Junkers	8 711 145 928 0	16	■	■	■	■	■	■	■						
	Thermometergehäuse 3T verp	8 735 100 555		■	■	■	■	■	■	■						
	Thermometergehäuse 1T verp	8 735 100 556		■	■	■	■	■	■	■						

PSW 500, 750, 1000-6 | PSW 750-6 PN6

- Pufferspeicher PSW 750-6 - 1000-6
- Buffer cylinder PSW 750-6 - 1000-6
- Ballon tampon PSW 750-6 - 1000-6
- Accumulatore puffer PSW 750-6 - 1000-6
- Bufferboiler PSW 750-6 - 1000-6
- Acumulador auxiliar PSW 750-6 - 1000-6



Bosch Thermotechnik GmbH
D-73249 Wernau / Germany